

***Building Design and Engineering
Approaches to Airborne Infection***

Basic Concepts of Ventilation Design

Jack Price

Ketabton.com

General Principles of Ventilation

Introduction

Need for ventilation:

- **Comfort**
- **Contamination Control**

both maintain healthy work environment

General Principles of Ventilation

- Office buildings ----- In-door air quality
- Occupational exposure ---- OSHA
- Environmental releases ---- EPA

General Principles of Ventilation

- **Regulatory Agencies** (compliance concerns)
 - Federal
 - State
 - Local
- **Good Practice**
 - Standard of care (industry standards ANSI, ASME, etc.)
 - Work productivity
 - Process control

Types of Systems

- **Supply**

Temperature & Humidity

Replacement (make-up air)

Return (recirculated air)

- **Exhaust**

General (dilution)

Local Control (hoods)

HVAC Systems

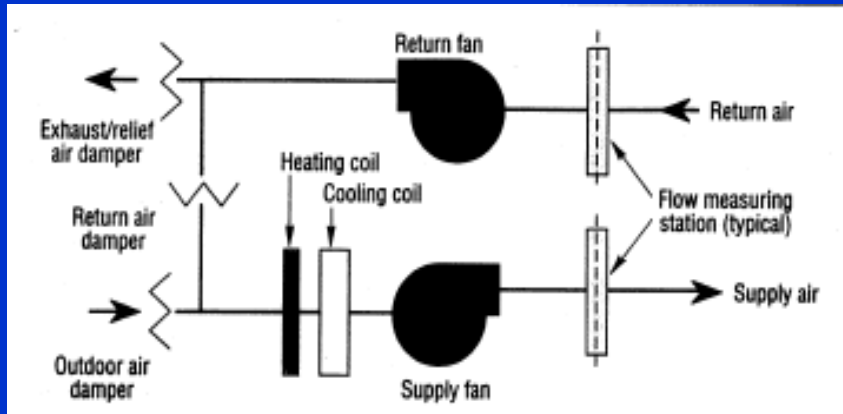

Air Handling System with Economizer

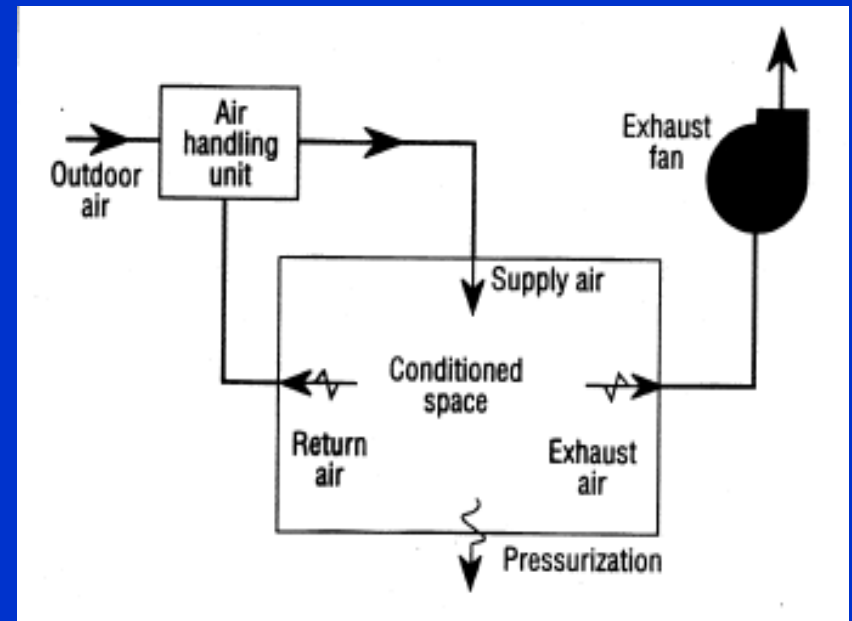

Air Balance in a Conditioned Space

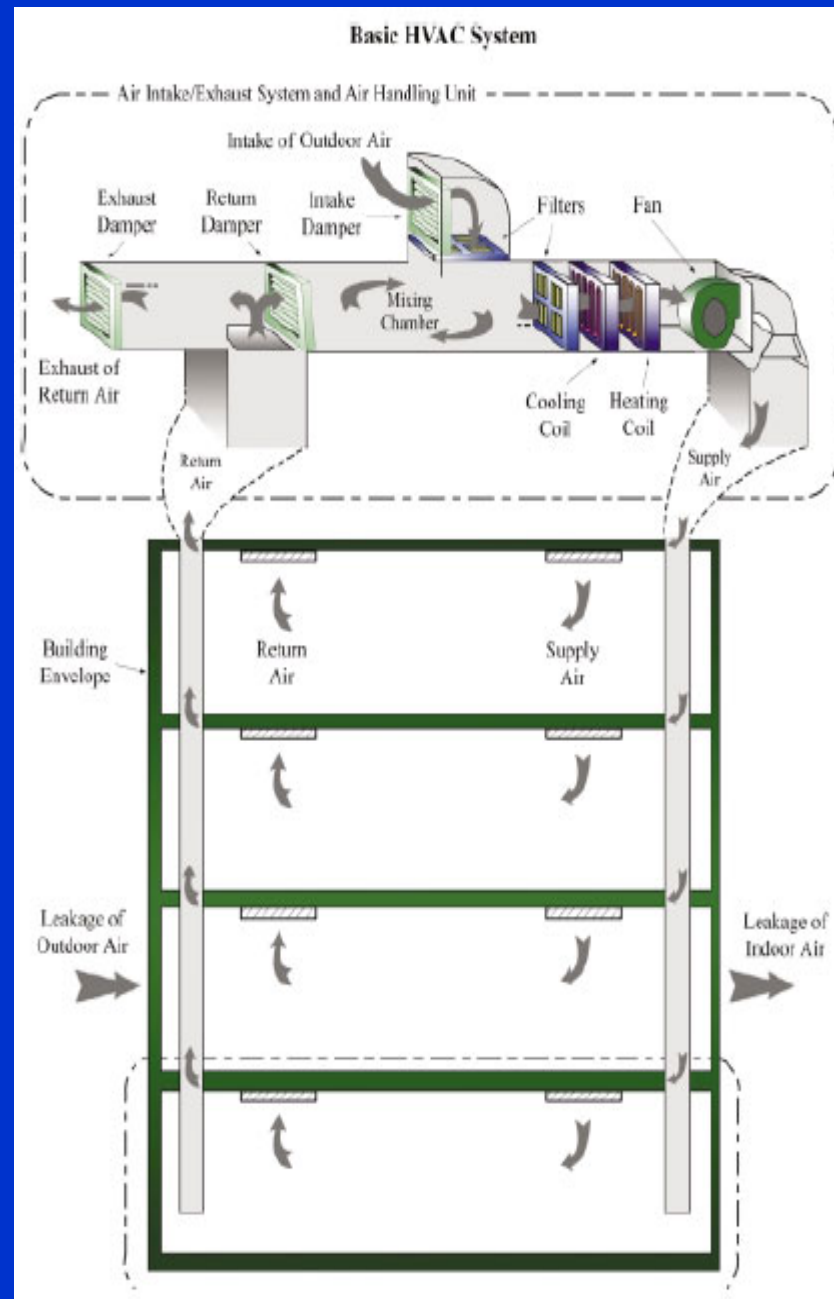

Design Concerns

- Temperature
- Pressure
- Air Contaminants
- Work Practices
- Product Protection
- Worker Protection
- Building Codes
- Equipment Selection
- Energy Conservation
- Maintenance
- Security
- Expansion

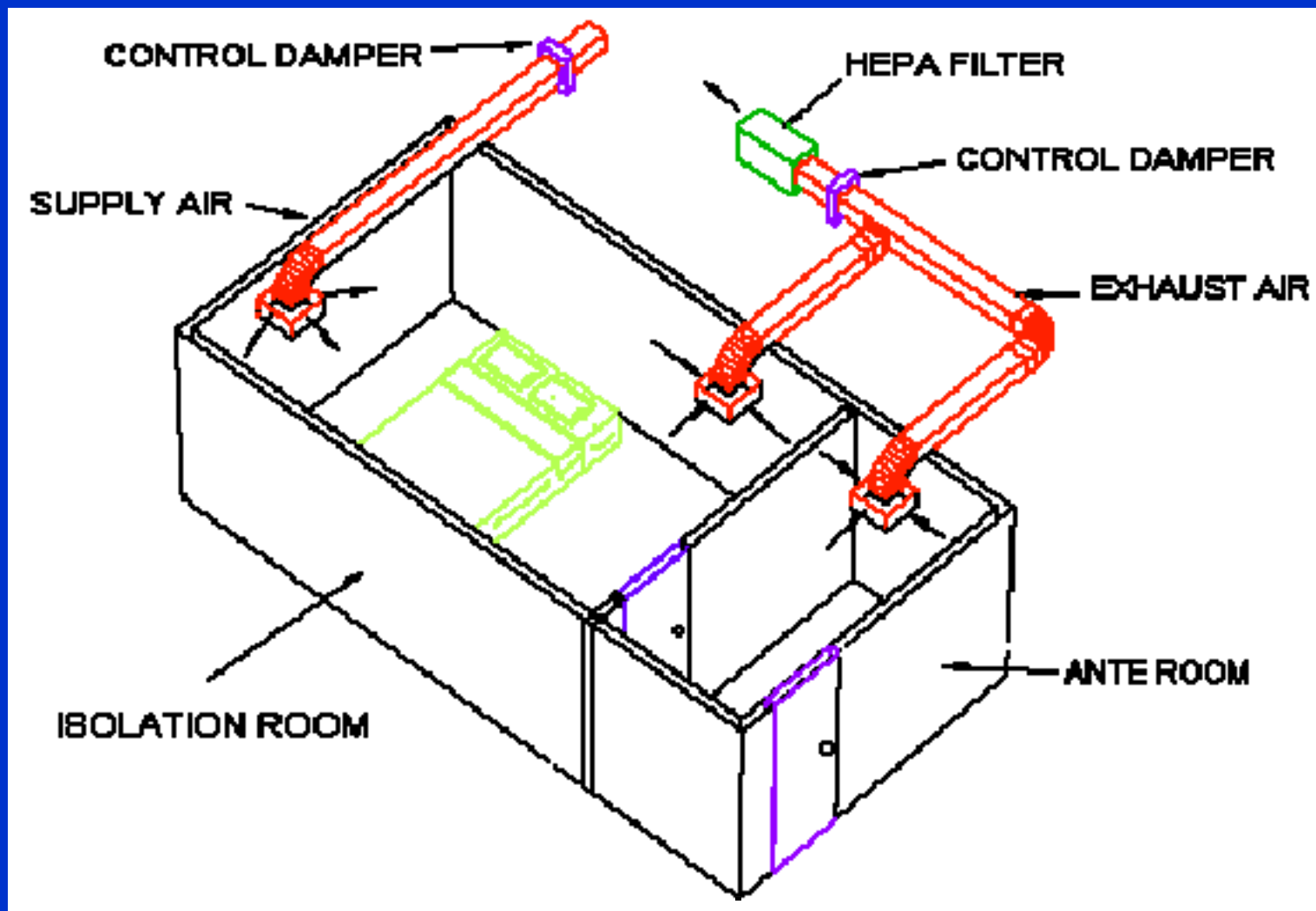

Patient Isolation Room with HEPA Exhaust Filtration

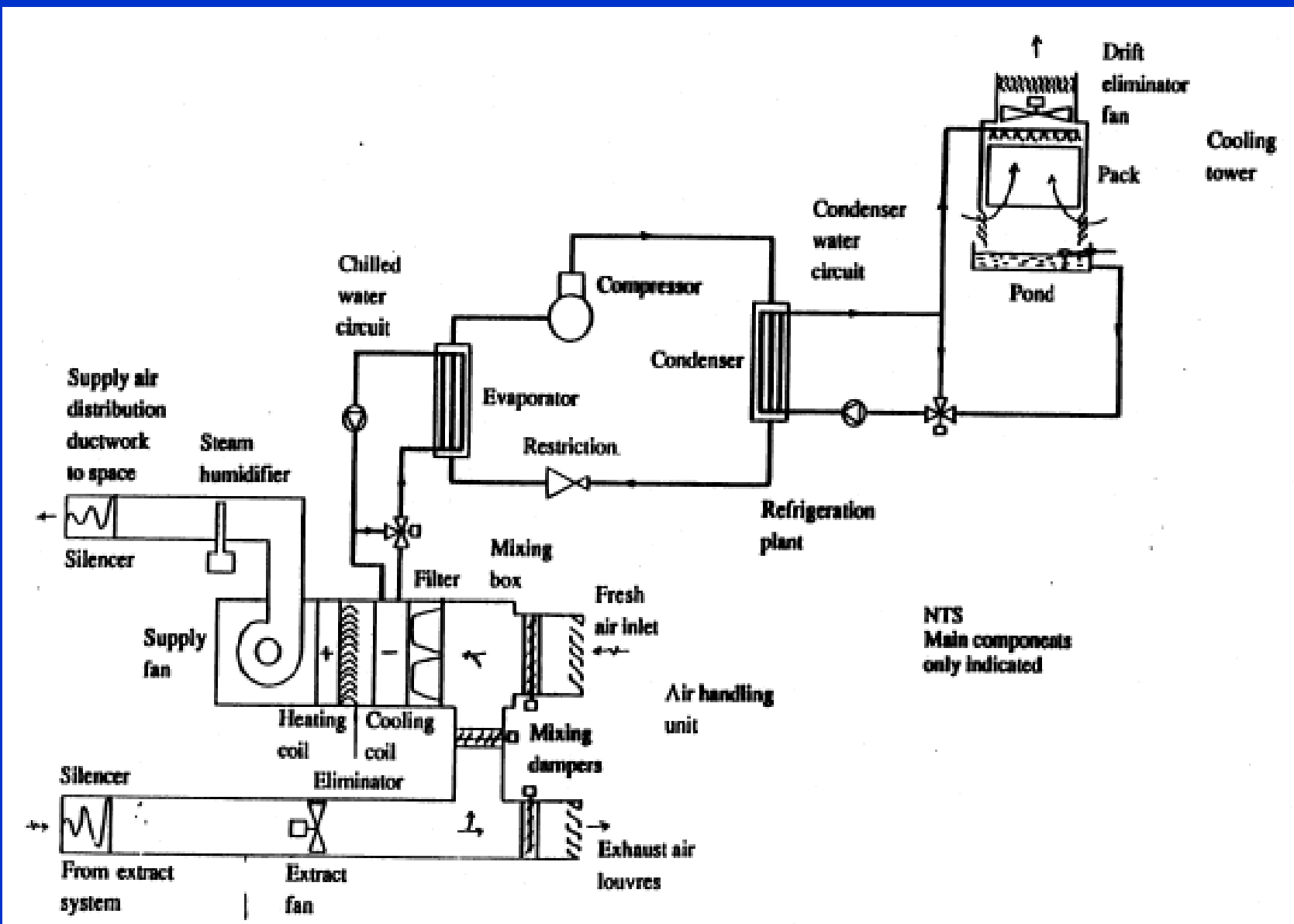

Air Conditioning System Water and Refrigeration Circuits

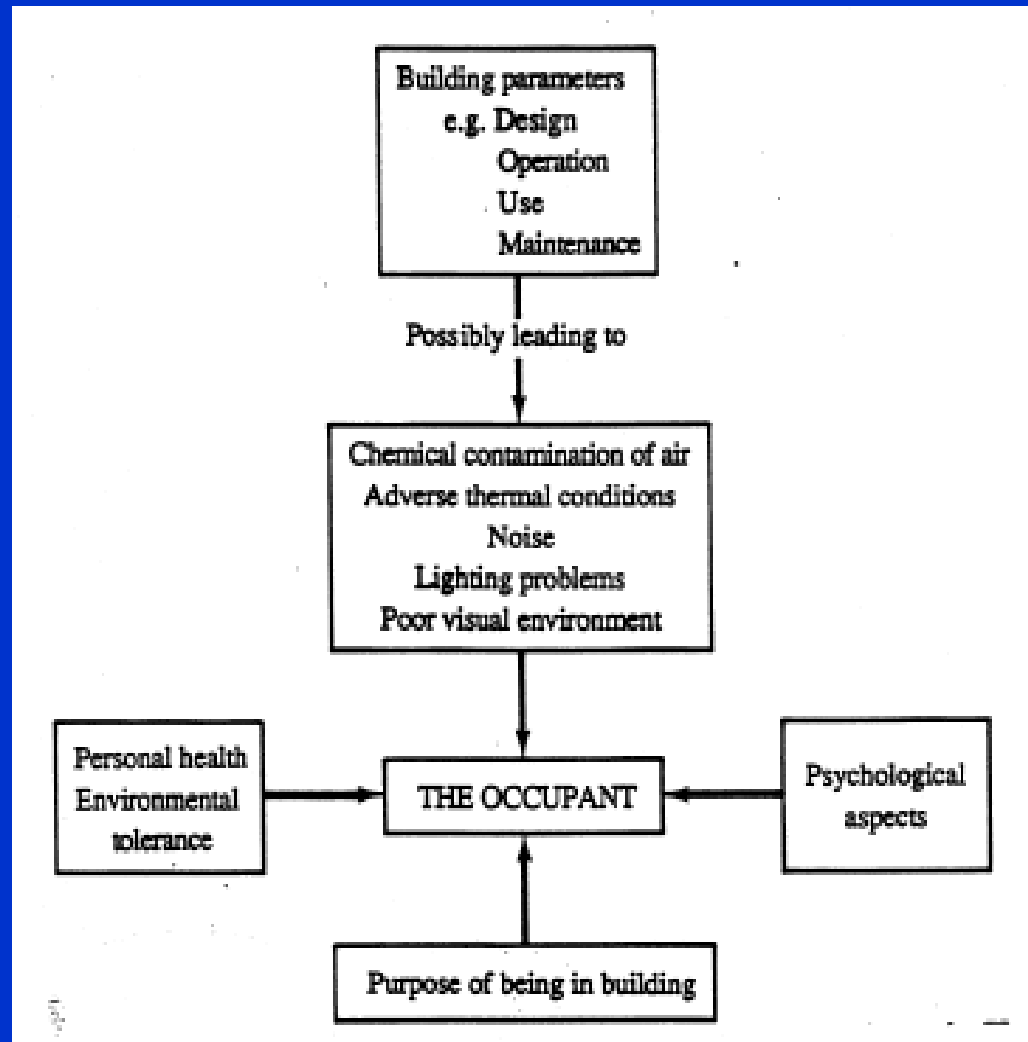

Factors in the Perception of Air Quality

Conversion Factors

Quantity	To Convert	Into	Multiply By:
Volumetric Flow	cubic feet/minute (ft ³ /min)	cubic meters/second (m ³ /sec)	4.719×10^{-4}
Velocity	feet/minute (fpm)	meters/second (m/s)	0.00508
Pressure	inches water (in w.g.)	Pascals (Pa)	249.1

Conservation of Mass

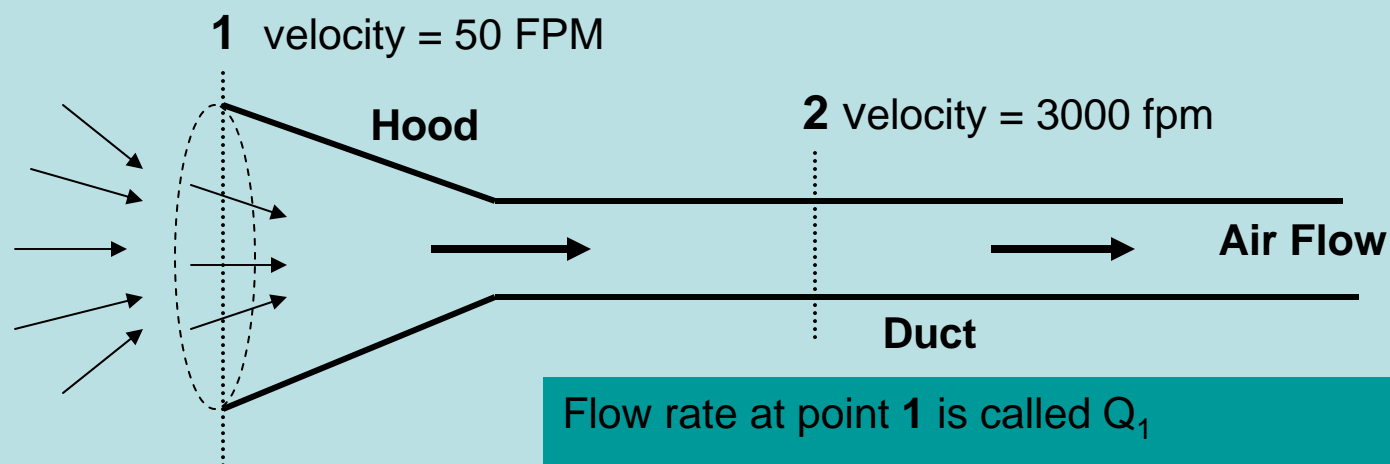

Flow rate at point 1 is called Q_1
and is equal to
flow rate at point 2 which is called Q_2

$$Q = V \cdot A$$

Where

Q = Volumetric Flow Rate, ft^3/min

V = Air Velocity, ft/min or fpm

A = Cross Sectional Area, ft^2 or SF

Conservation of Mass

$$Q = V \cdot A$$

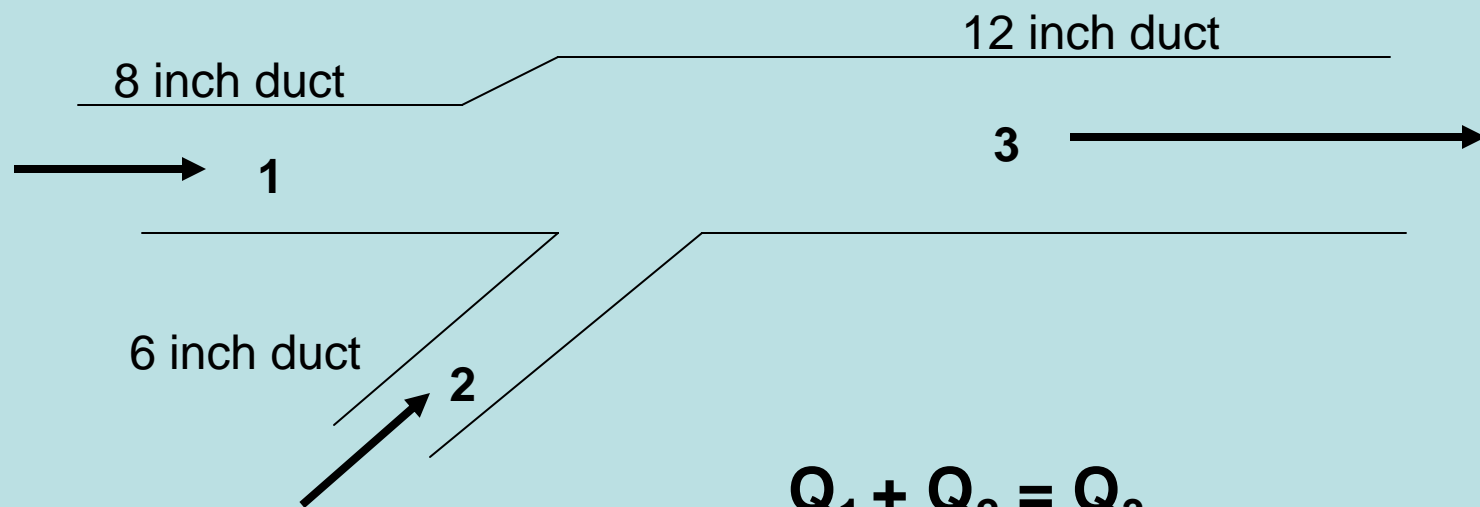

$$Q_1 + Q_2 = Q_3$$

$$V_1 A_1 + V_2 A_2 = V_3 A_3$$

AIR FLOW

- At standard temperature and pressure (STP):

* 1 atmosphere & 70° F *

The density of air is $0.075 \text{ lb}_m/\text{ft}^3$

- Air will flow from a higher pressure region to a lower pressure region
- Three Different Types of Pressure Measurements
 - * Static * Velocity * Total *

Types of Pressure Measurements

- **Static Pressure (S_P)**

potential energy
can be + or -

bursting or collapsing
measured perpendicular to flow

- **Velocity Pressure (V_P)**

kinetic energy
Exerted in direction of flow

accelerates from 0 to some velocity
always +

- **Total Pressure (T_P)**

combined static & velocity components
can be + or -

measure of energy content of air stream
Always decreasing as flow travels
downstream thru a system only rising when
going across a fan

$$TP = SP + VP$$

TP	- +
SP	- +
VP	+

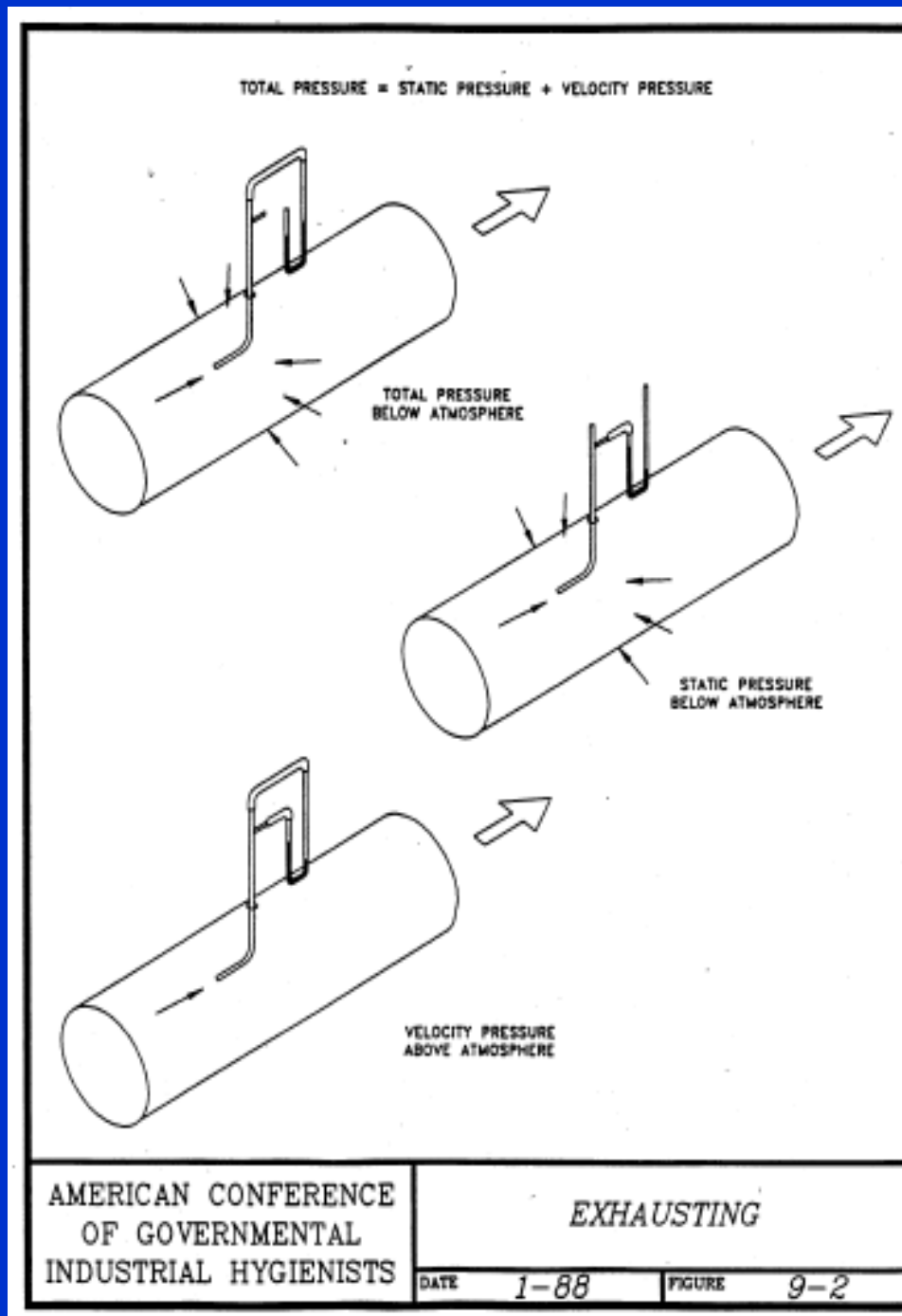

Conservation of Energy

- $TP = SP + VP$ or $T_P = S_P + V_P$
- Energy losses:
 - Acceleration of air
 - Hood entry
 - Duct losses: friction (function of system materials & design)
 - Fitting losses: contractions & expansions
- $T_{P1} = T_{P2} + h_L$ now substitute $T_P = S_P + V_P$
- $S_{P1} + V_{P1} = S_{P2} + V_{P2} + h_L$

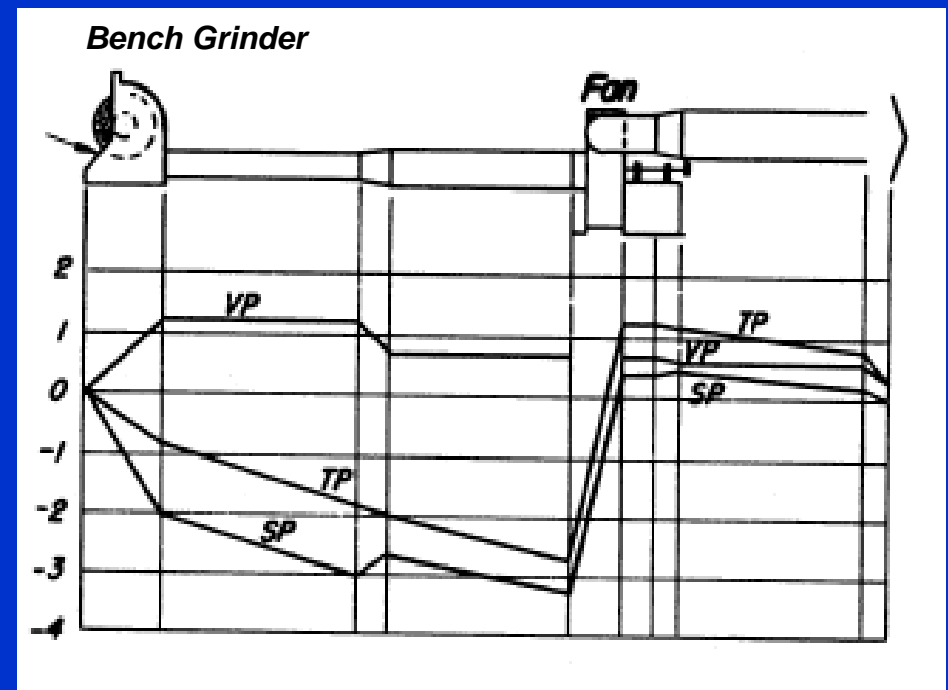
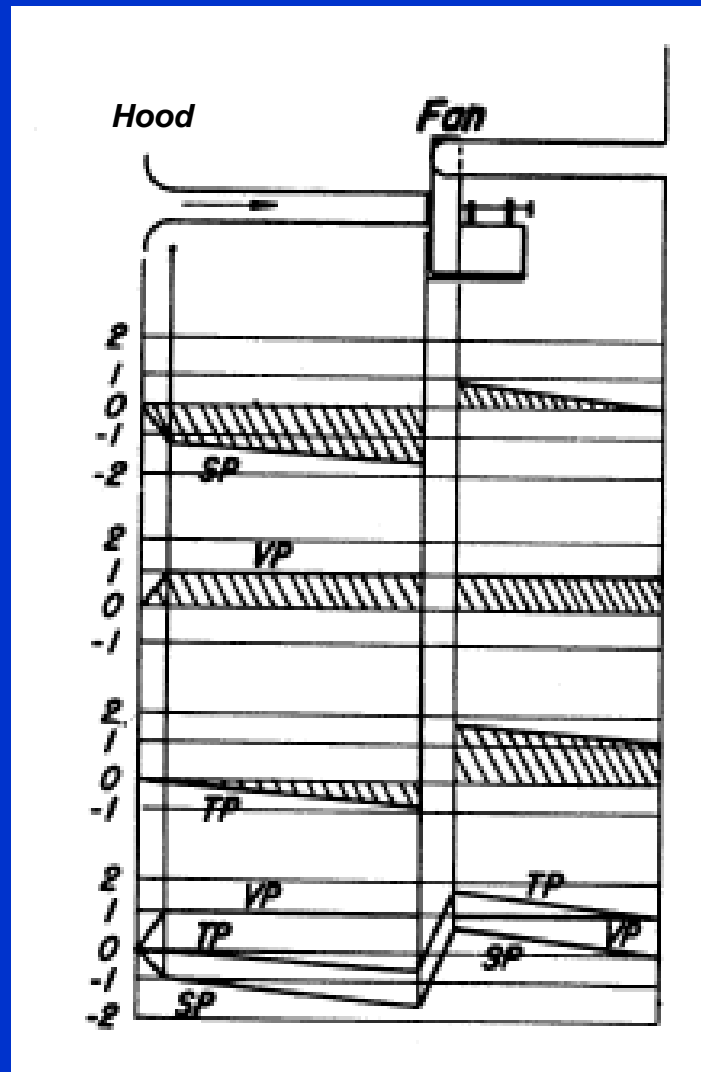

Pressure Graphs for TP, SP, and VP

Velocity Pressure & Velocity

- $V = 1096 (V_P/\rho)^{0.5}$

where ρ = air density
@ STP $\rho = 0.075 \text{ lb}_m/\text{ft}^3$

- **$V = 4005 (V_P)^{0.5}$**

- Velocity pressure is a function of the velocity and fluid density.
- Velocity pressure will only be exerted in the direction of air flow and is always positive.

Bench Grinder Exhaust Ventilation

1

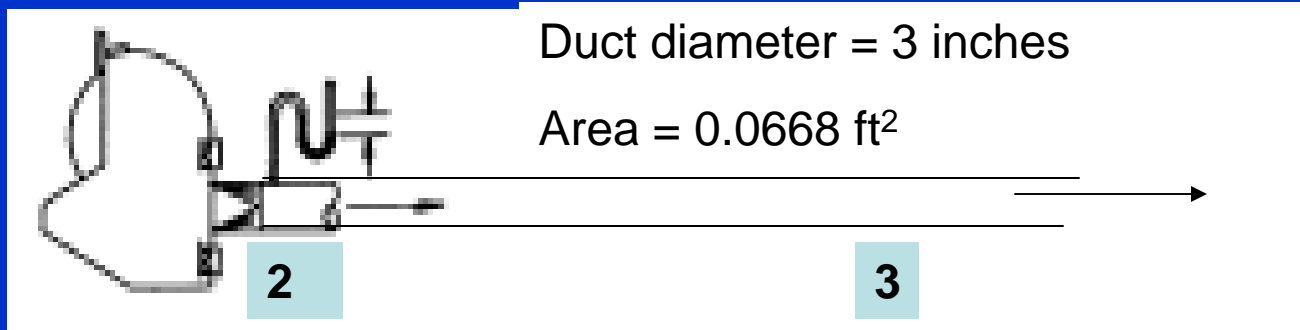

- $Q_1 = Q_2$
- If Q desired is 300 cfm
- Then $Q = V A$
 $V = Q / A$
 $V = (300) / (0.0068)$
 $V = 4490 \text{ fpm}$

- If there are no losses from the grinder hood entry then:

$$SP_1 + VP_1 = SP_2 + VP_2$$

but: $SP_1 = 0$ and $VP_1 \rightarrow 0$

we then have:

$$0 = SP_2 + VP_2$$

or

$$-VP_2 = SP_2$$

Bench Grinder Exhaust Ventilation

1

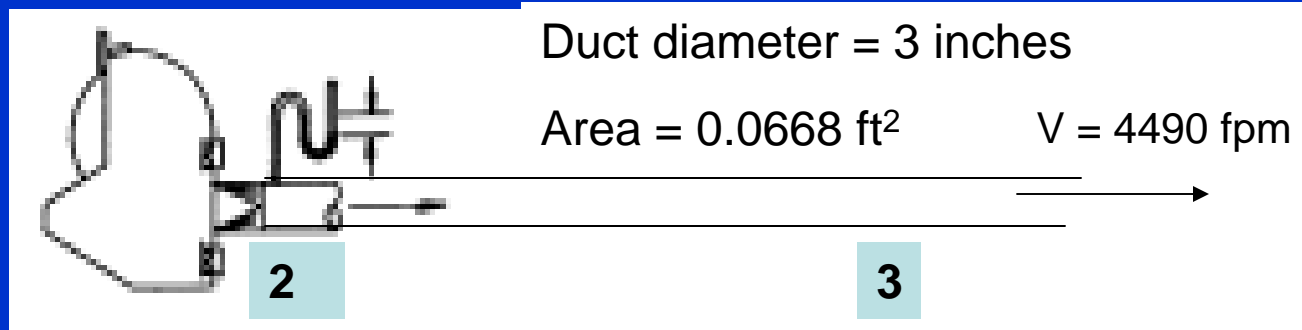

- If there are no losses from the grinder hood entry then:

$$SP_1 + VP_1 = SP_2 + VP_2$$

but: $SP_1 = 0$ and $VP_1 \rightarrow 0$

we then have:

$$0 = SP_2 + VP_2$$

or $SP_2 = (-VP_2)$

- from $V = 4005 (VP)^{0.5}$
- $VP_2 = (4490/4005)^2$
- $VP_2 = 1.26$ in w.g.
- then: $SP_2 = (-VP_2)$
 $SP_2 = -1.26$ in w.g.

Bench Grinder Exhaust Ventilation

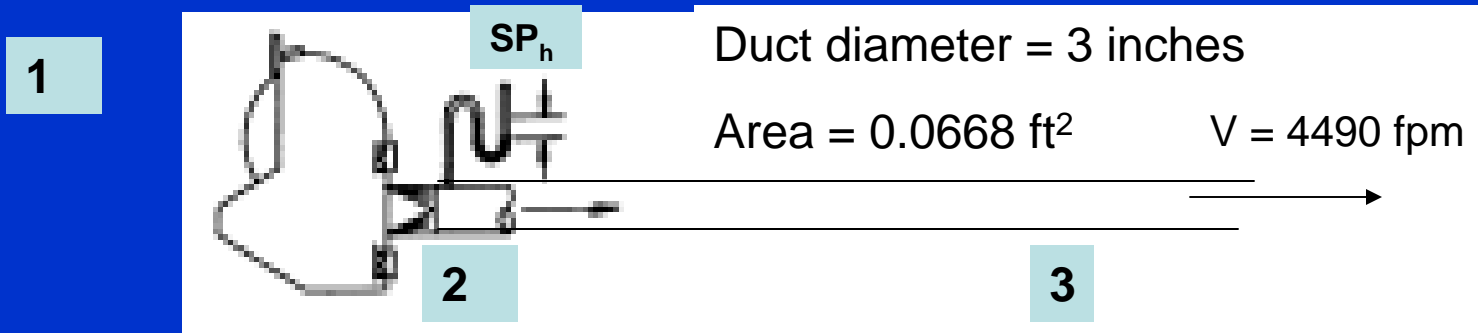

- However there are losses thru the grinder hood entry
$$\mathbf{SP_2 = - (VP_2 + h_e)}$$
 where h_e is the energy loss of the hood entry
- Static pressure (**SP**) must decrease due to acceleration of air up to the duct velocity
- F_h is defined as the energy loss factor (for that hood design)
- Energy losses will be measured as a function of the velocity pressure in the system
$$\mathbf{h_e = (F_h) (VP)}$$
- Now we define the static pressure at the hood as **SP_h**
- **SP_h** is also called the hood static suction and is the absolute value of **SP₂**

Bench Grinder Exhaust Ventilation

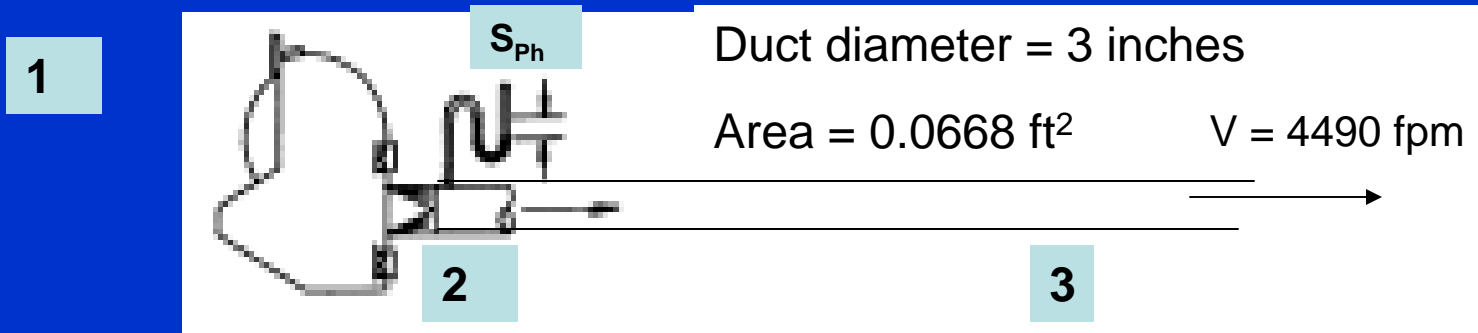

- Now add the hood entry loss:

$$SP_h = VP_2 + h_e = VP_2 + (F_h) (VP_2)$$

Assume that the hood energy loss factor for this hood is 0.40

- $SP_h = 1.26 + (0.40) (1.26) = 1.76$ in w.g.

Figure 1. Relationship Between Hood Static Pressure and Flow Rate Entering Hood

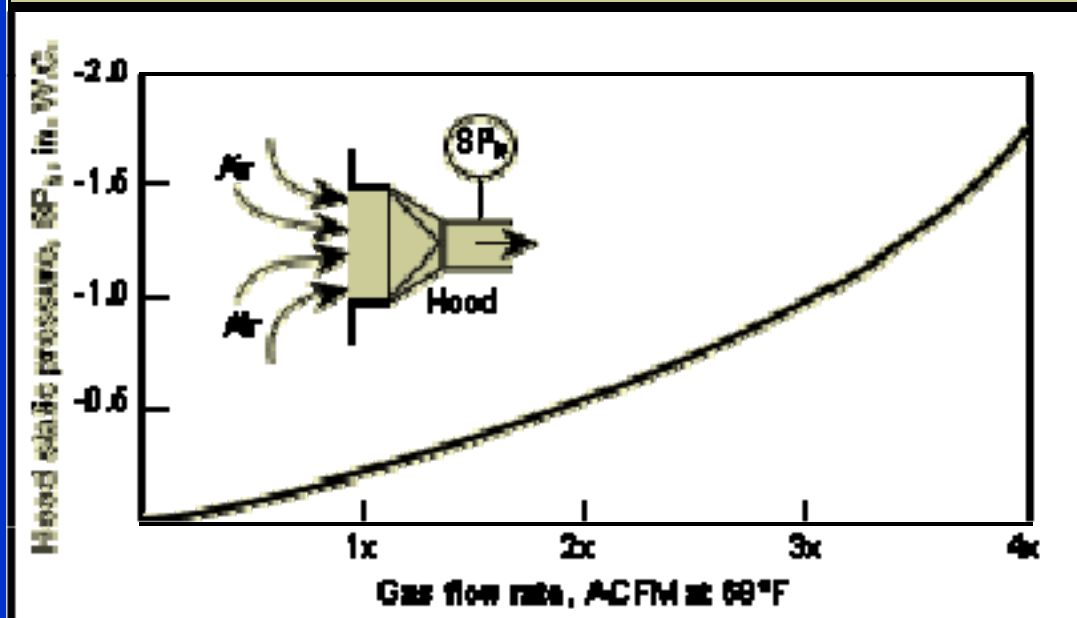

Figure 2. Air Flow Convergence in a Duct

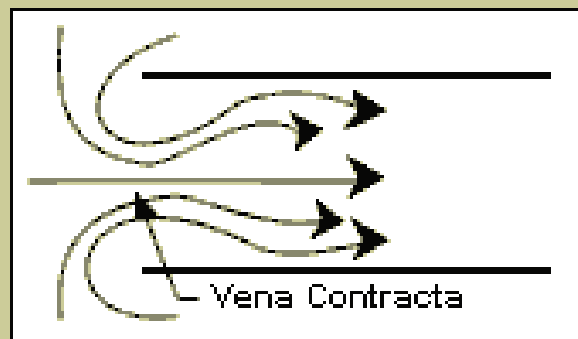

Figure 3. Hood Entry Loss Coefficients (F_d) for Various Duct Designs

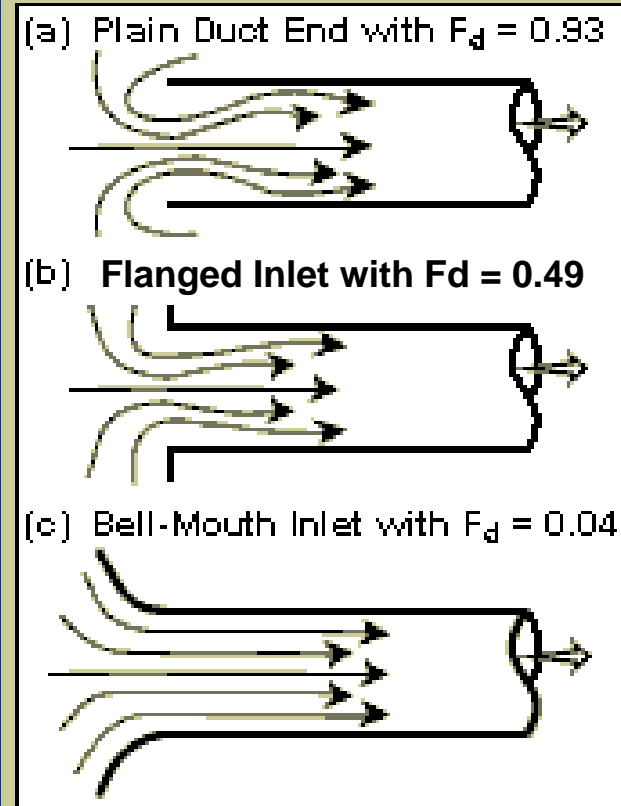
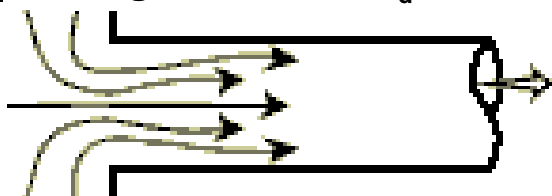

Figure 3. Hood Entry Loss Coefficients (F_d) for Various Duct Designs

(a) Plain Duct End with $F_d = 0.93$







(b) Flanged Inlet with $F_d = 0.49$

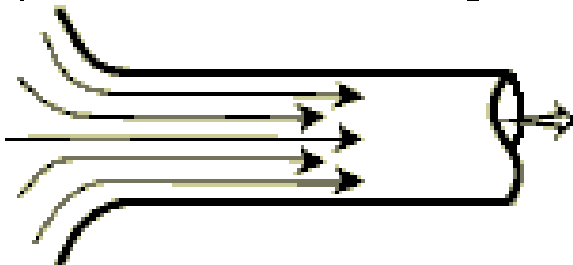

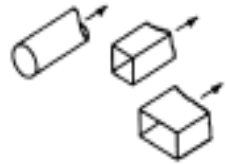
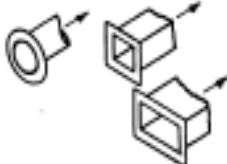
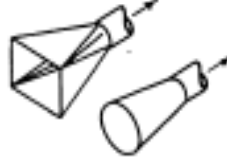
(c) Bell-Mouth Inlet with $F_d = 0.04$



HOOD TYPE	DESCRIPTION	COEFFICIENT OF ENTRY, C_e	ENTRY LOSS
	PLAIN OPENING	0.72	0.93 VP
	FLANGED OPENING	0.82	0.49 VP
	TAPER or CONE HOOD	Varies with angle of taper or cone. See Fig. 6-10	
	BELL MOUTH INLET	0.98	0.04 VP
	ORIFICE	See Fig. 6-10	
	TYPICAL GRINDING HOOD	STRAIGHT TAKE-OFF	
		0.78	0.65 VP
		TAPERED TAKE-OFF	
		0.85	0.40 VP

Hood Entry Coefficients

Actual Flow

$$C_e = \frac{\text{Actual Flow}}{\text{Hypothetical Flow } \textit{no losses}}$$

$$C_e = \frac{(4005) (VP)^{0.5} (A)}{(4005) (SP_h)^{0.5} (A)} = \frac{(VP)^{0.5}}{(SP_h)^{0.5}}$$

$$C_e = (VP/SP_h)^{0.5}$$

Hood Entry Coefficients

$$C_e = (VP/SP_h)^{0.5}$$

Typical values for C_e are known for some hoods.

For the bench grinder hood with a straight take-off :

$$C_e = 0.78$$

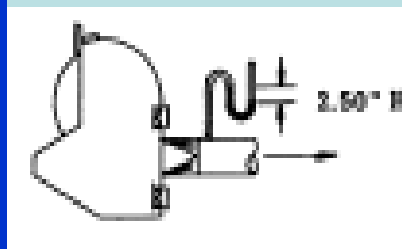

Example Problem

- What static pressure (SP_h) should be set at the bench grinder hood to maintain a duct velocity of 4000 fpm if the take-off duct size is 4 inch diameter ?
- What is the volumetric flow rate ?

Example Problem

- $V = 4000$ fpm $Q = VA = 4005(A)(VP)^{0.5}$ $Q = VA = 348$ cfm
- A for 4 inch duct diameter = 0.087 ft²
- C_e bench grinder hood = 0.78

$$C_e = (VP/SP_h)^{0.5} = 0.78$$

$$(VP/SP_h) = (0.78)^2$$

$$SP_h = VP/(0.78)^2 = (0.998)/(0.608) = 1.64 \text{ in w.g.}$$

$$V = 4005 (VP)^{0.5}$$

$$(VP)^{0.5} = (4000)/(4005)$$

$$VP = 0.998 \text{ in w.g.}$$

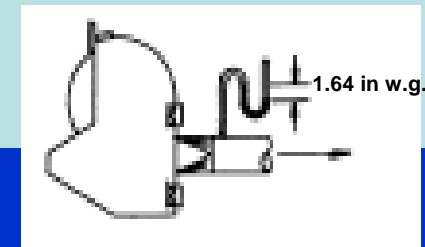

Air Flow Characteristics

- See Industrial Ventilation Manual notes

Blowing vs. Exhausting

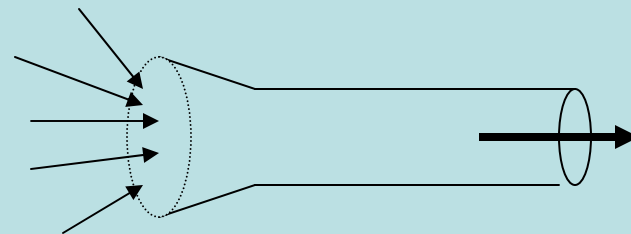
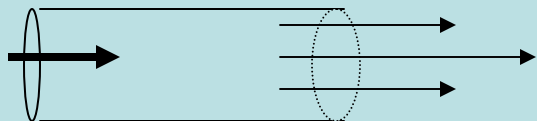

Air Flow Characteristics

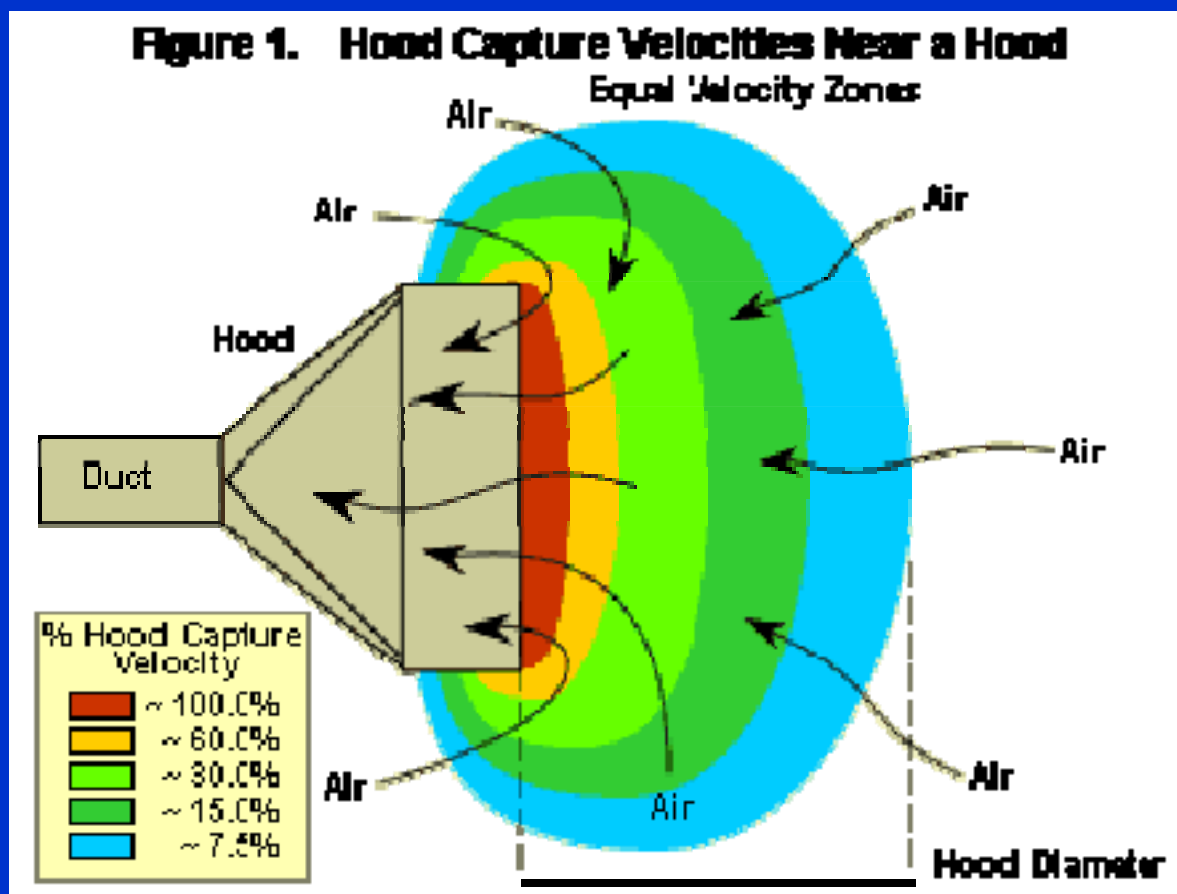

Exhaust Hoods

Capture Velocity

From Dalla Valle's empirical work

$$V_{(x)} = Q / (10 x^2 + A)$$

**Figure 1. Hood Capture Velocities Near a Hood
Equal Velocity Zones**

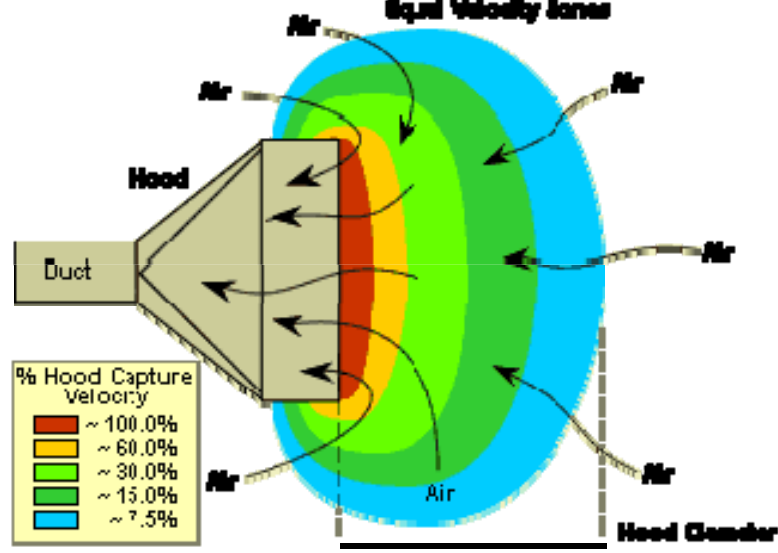

Capture Velocity

$$V_{(x)} = Q / (10 X^2 + A)$$

Figure 2. Hood Capture Velocity Equation (without Flange)

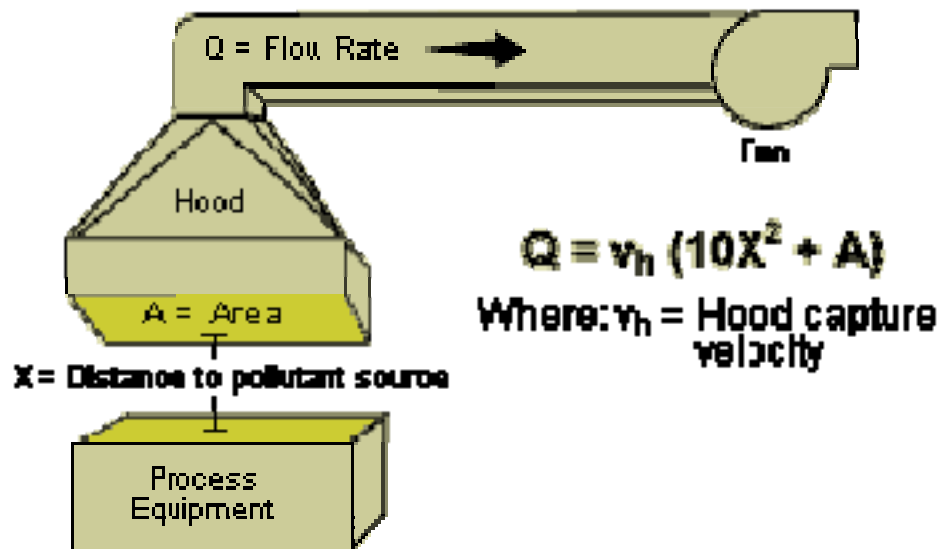

Capture velocity is only effective in the immediate vicinity of the hood

Room supply air (make-up air) discharge can influence effectiveness of hood capture

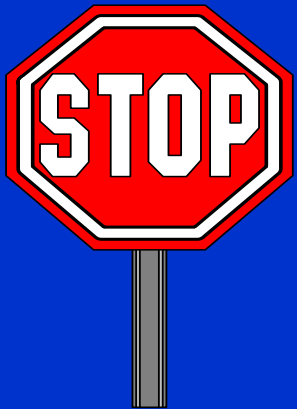

Questions ?

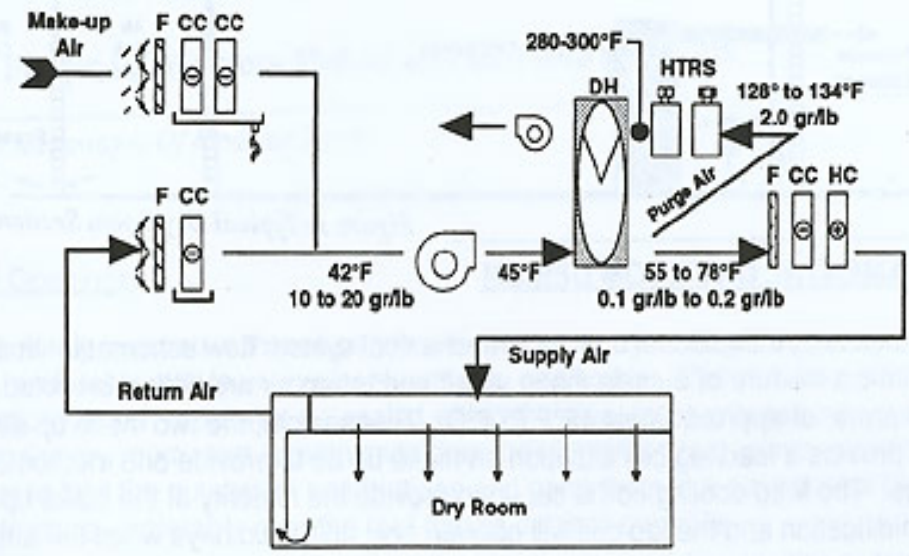
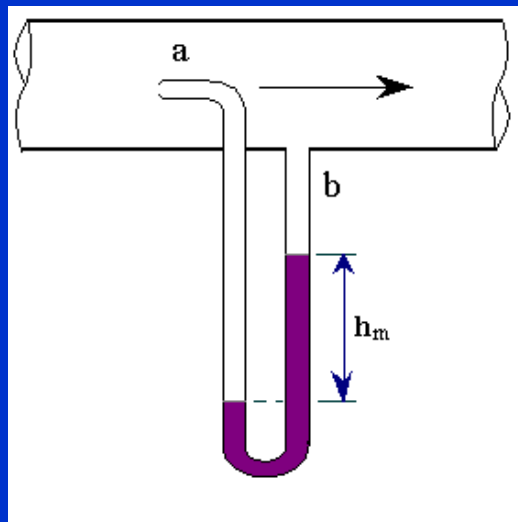
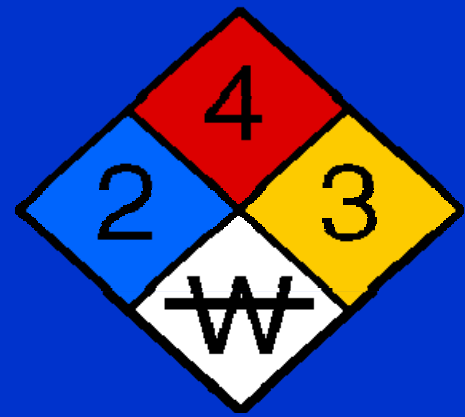
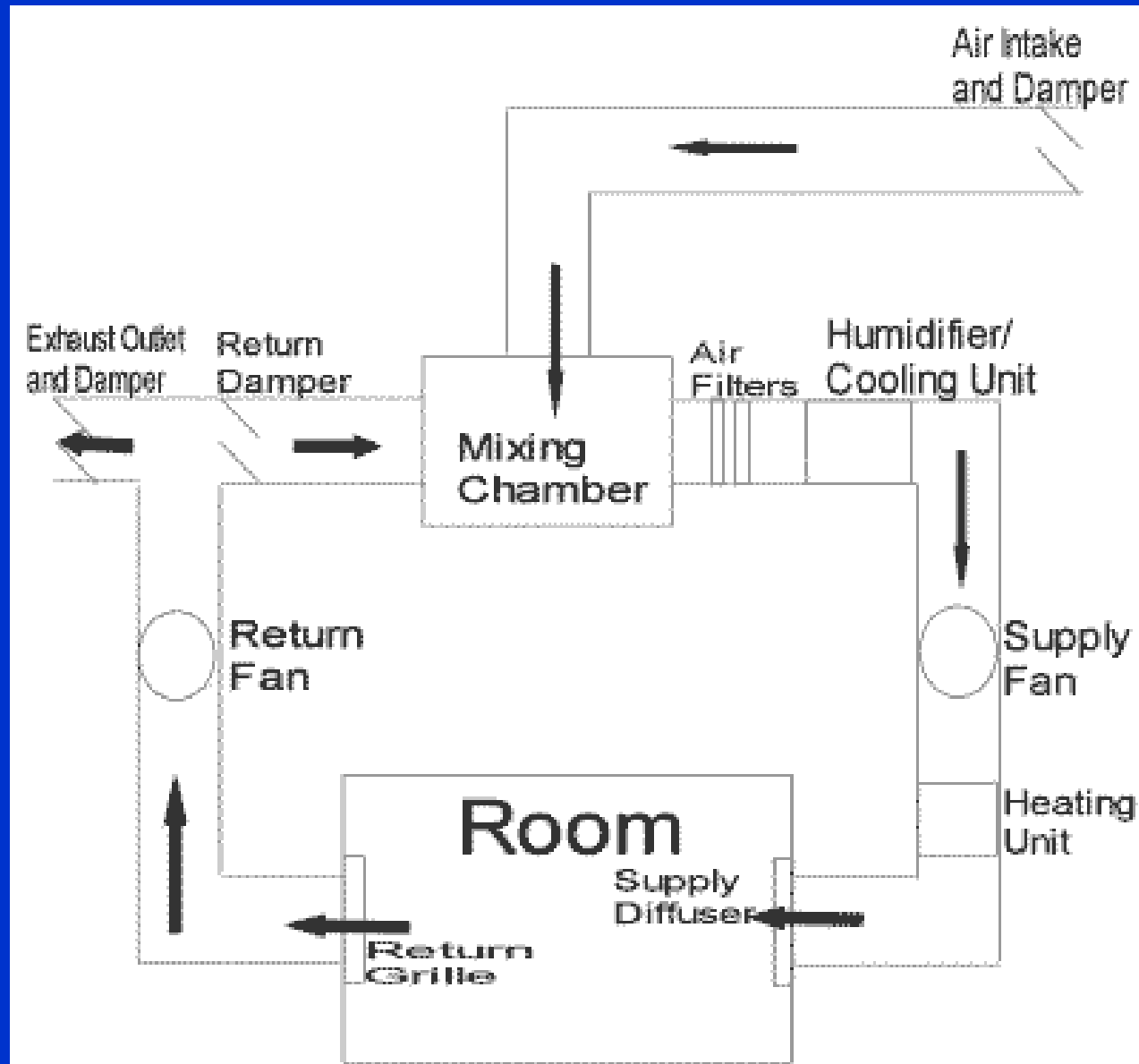

Figure 4- Typical Dry Room Mechanical System

In-Place Filter Testing Workshop

Ventilation Systems: Operation and Testing

HVAC Systems



HVAC Systems

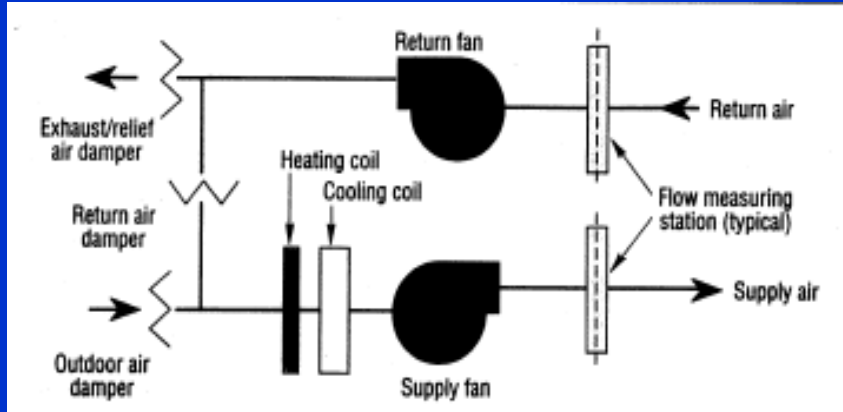

Air Handling System with Economizer

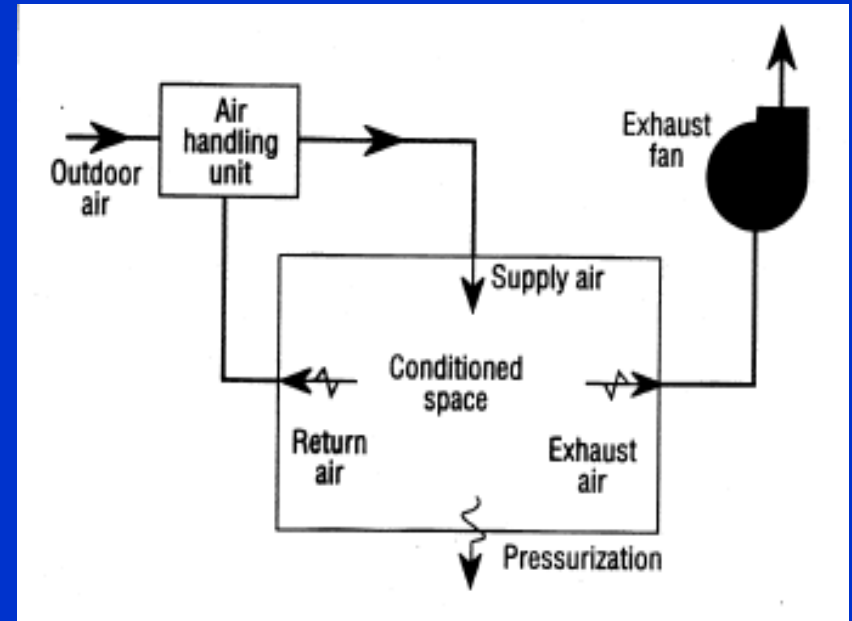

Air Balance in a Conditioned Space

Figure 2. Centrifugal Fan Components

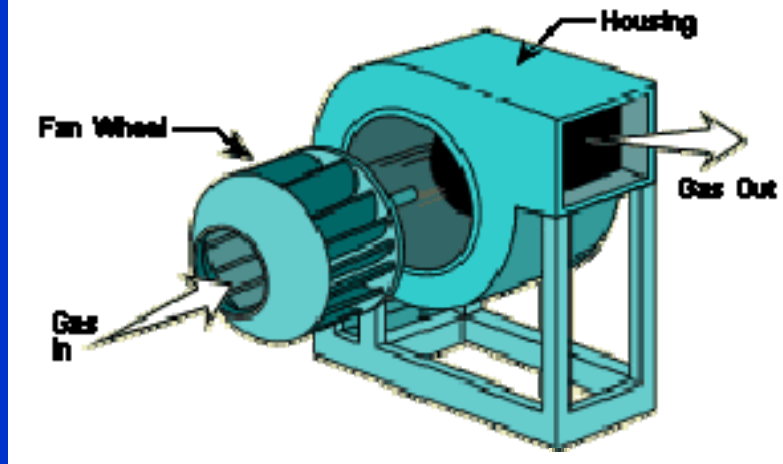

Figure 3. Centrifugal Fan and Motor Sheaves

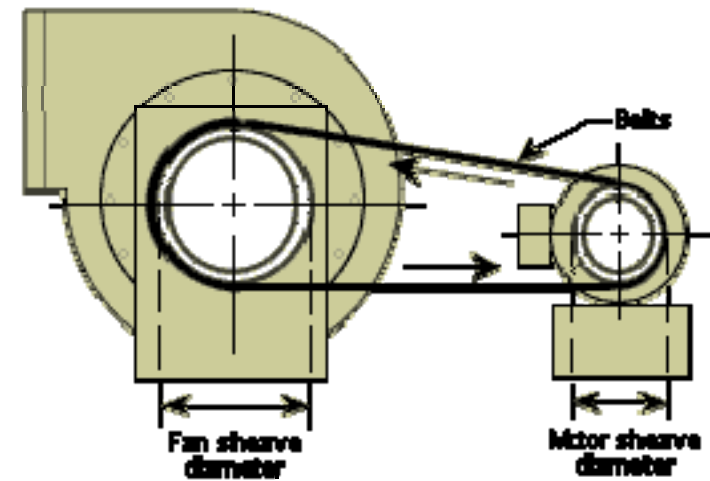
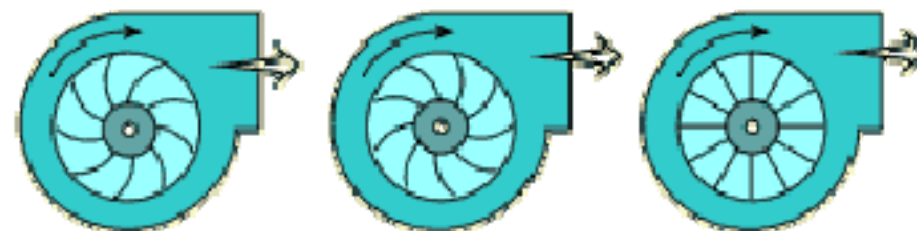

Figure 4. Types of Fan Wheels:



(a) Forward Curved

(b) Backward Curved

(c) Radial

Figure 3. Total System Static Pressure Drop

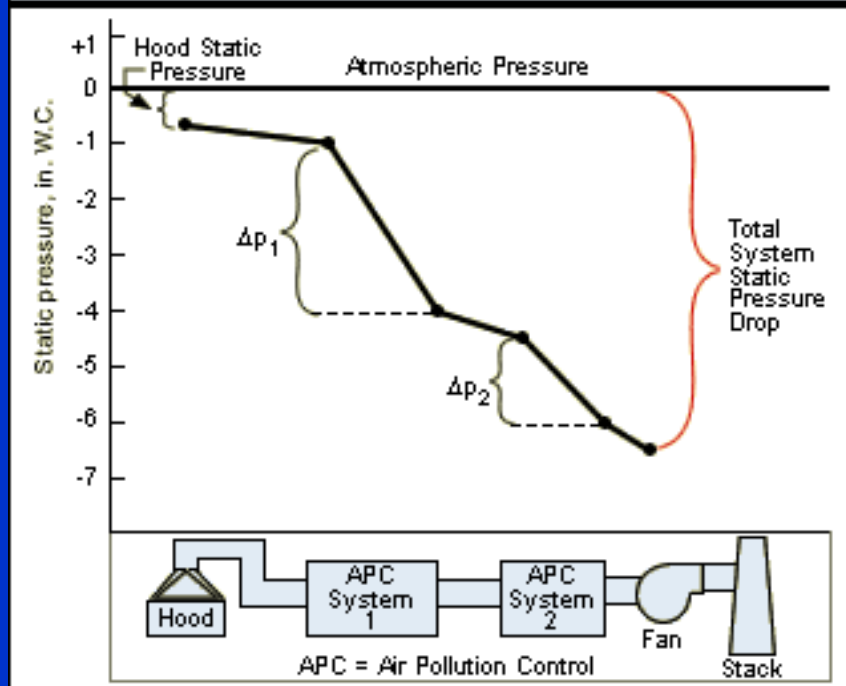

Figure 4. System Characteristic Curve

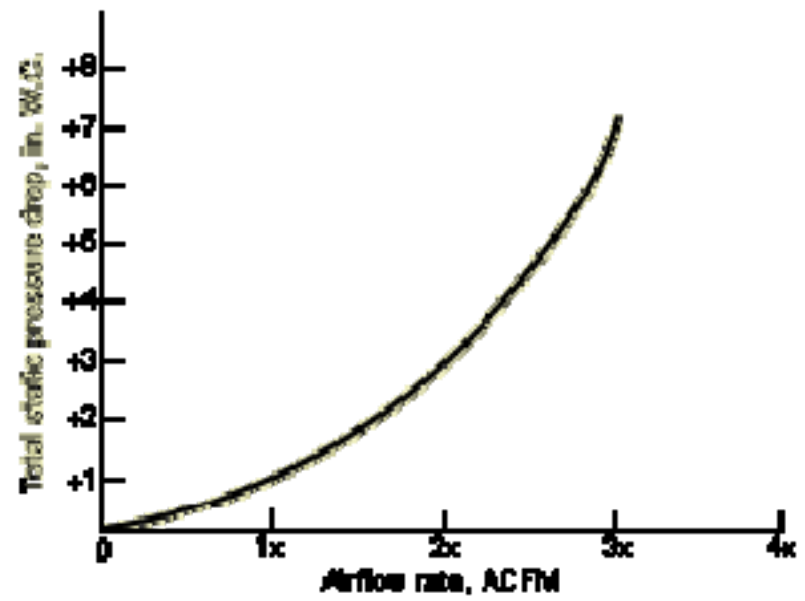

Figure 7. Fan Characteristic Curve

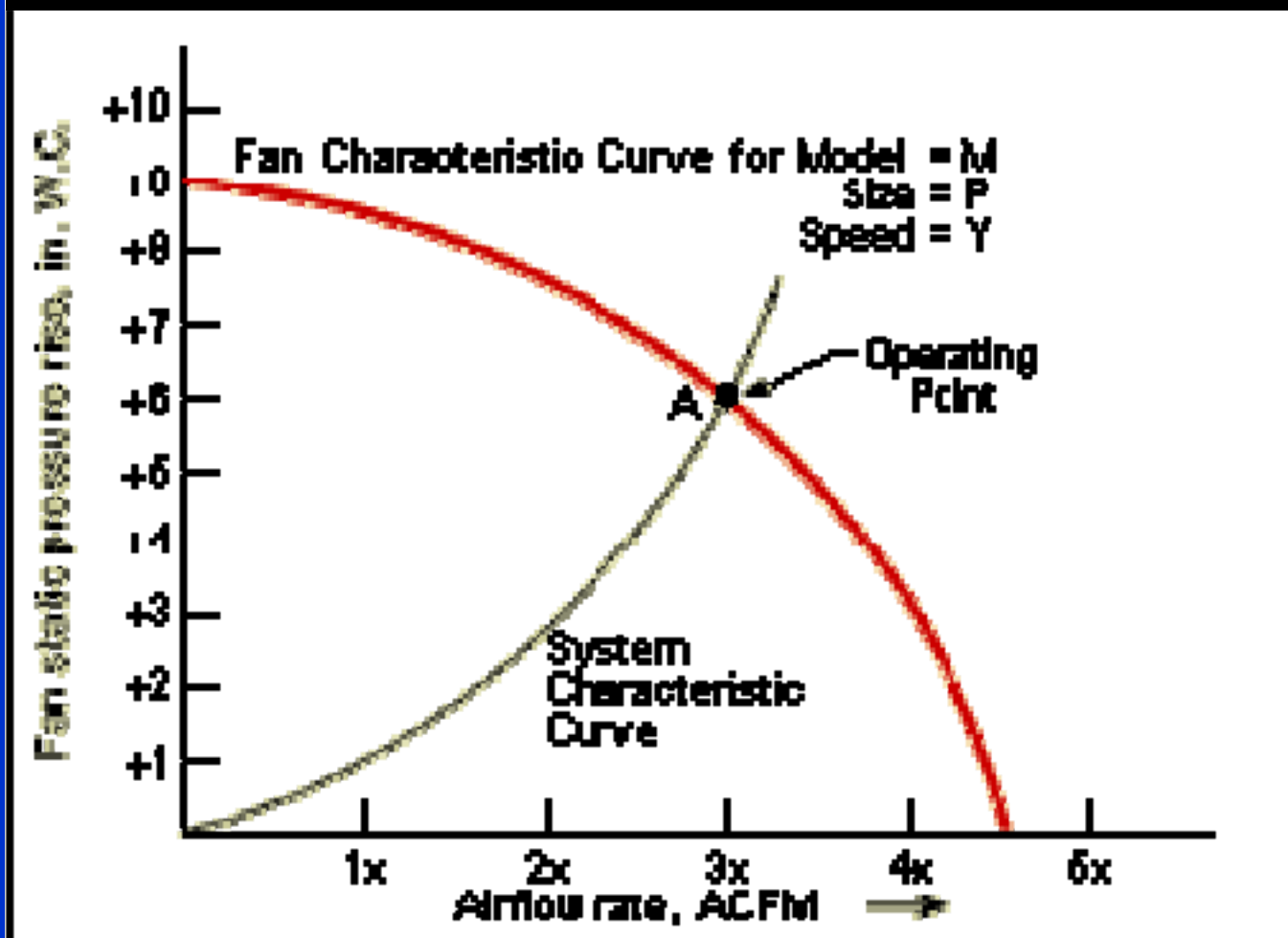

Figure 8. Effect of a Change in the System Characteristic on the Operating Point

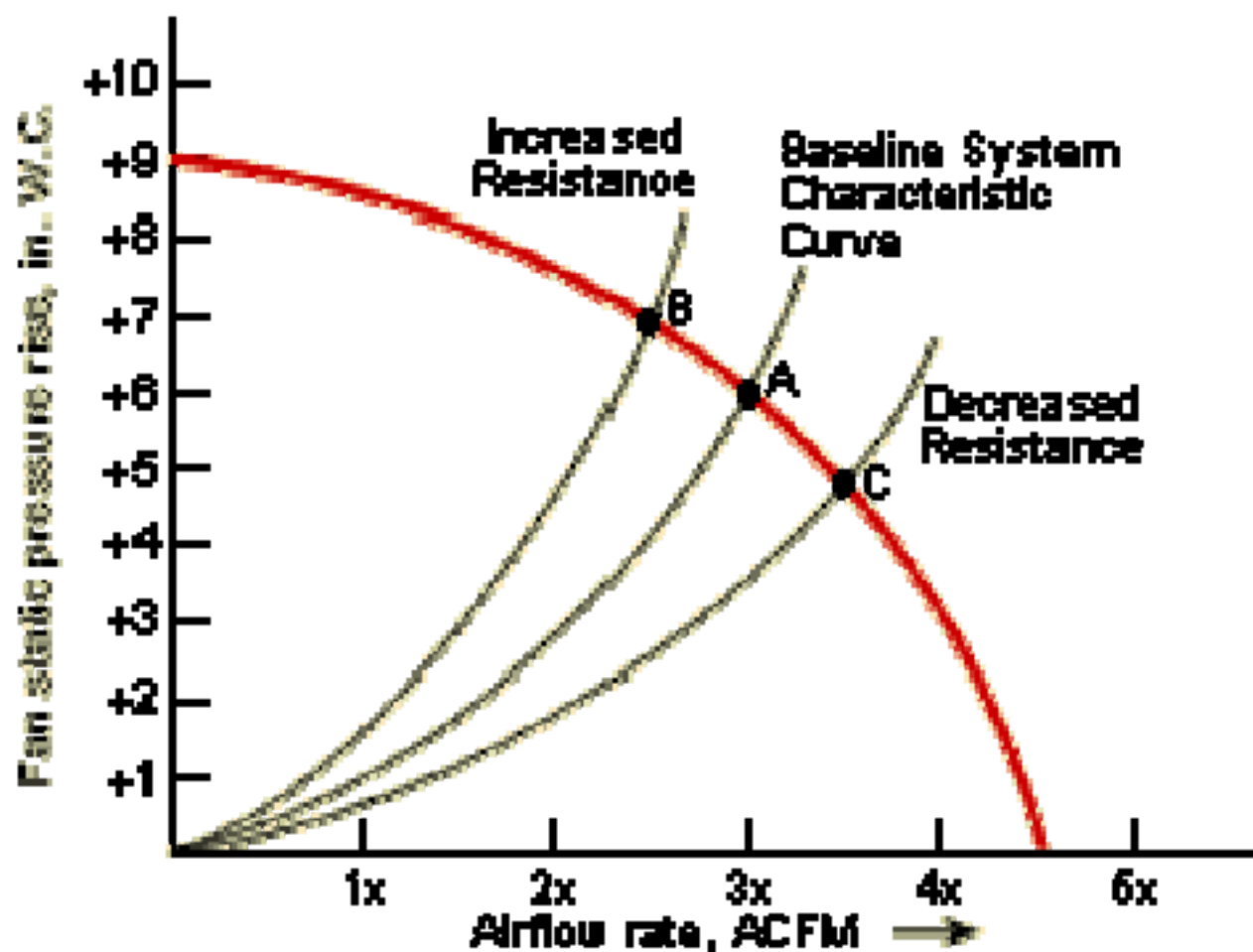
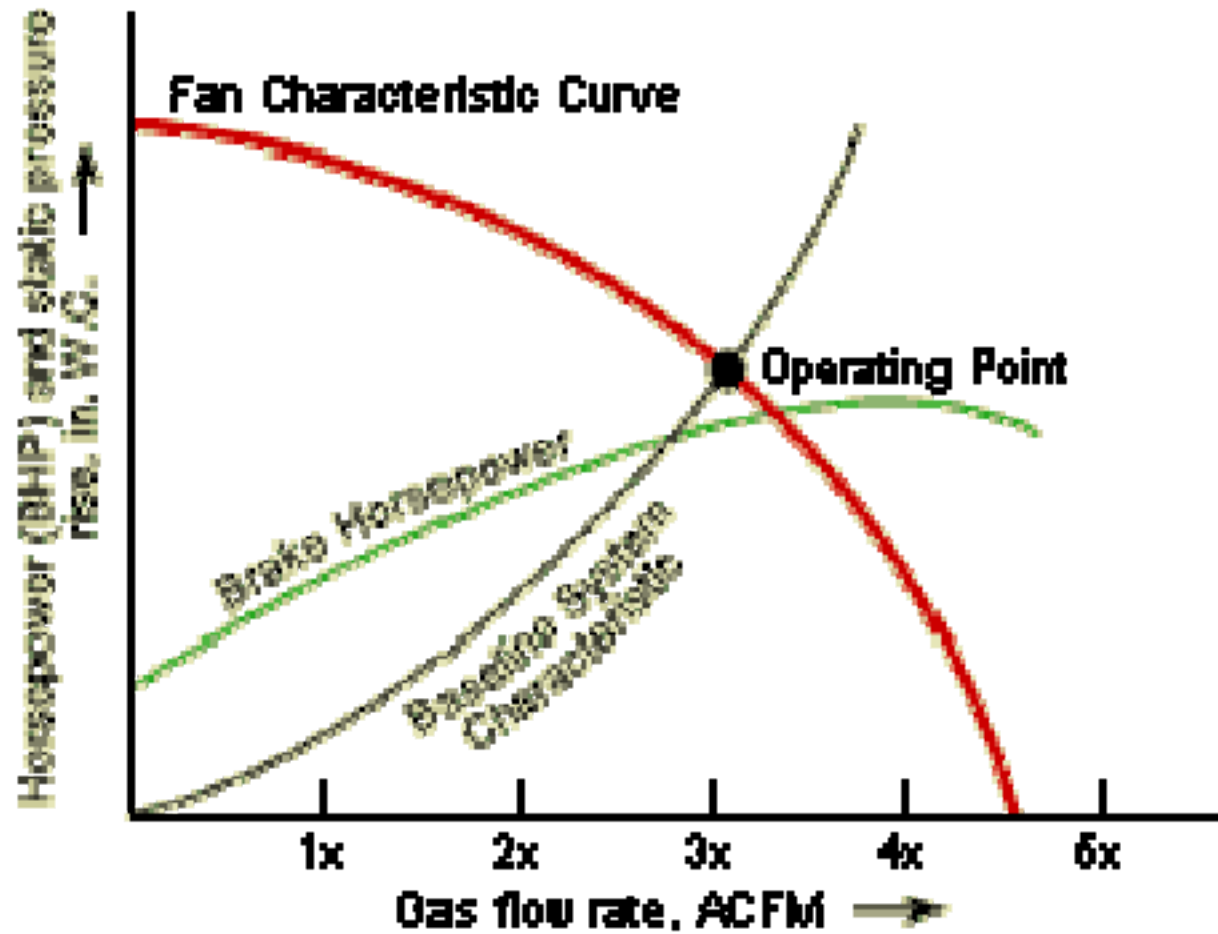
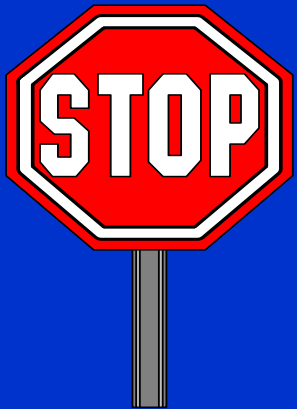

Figure 1. Example of a Brake Horsepower Curve





Questions ?

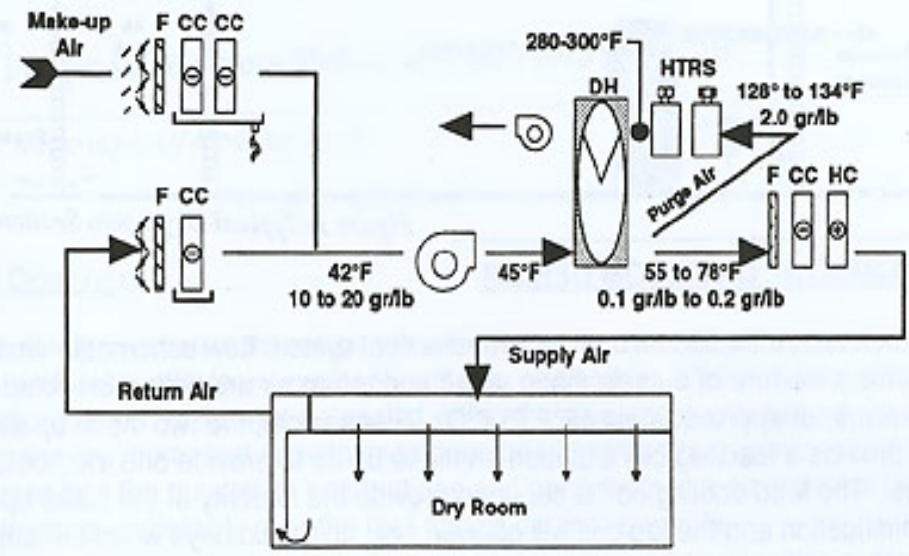
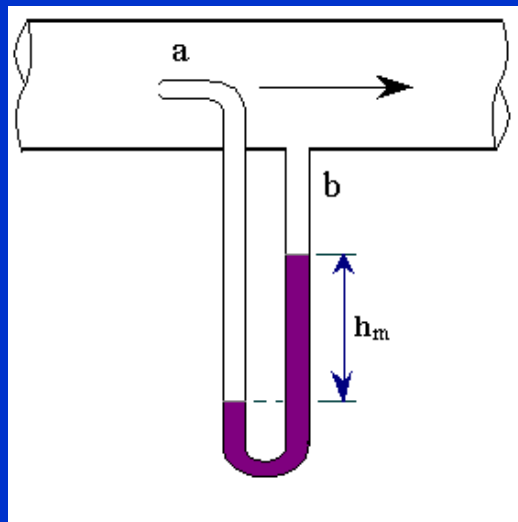

Figure 4- Typical Dry Room Mechanical System

**Get more e-books from www.ketabton.com
Ketabton.com: The Digital Library**